



TONE WINNER



HD-3100 User Manual

ISO9001 Certified Enterprise



Product packing list

Number	Item	Quantity
1	Manual (Include warranty card)	1 piece
2	Power cord	1 piece
3	Certificate	1 piece
4	Battery(air shipment no battery)	1 piece
5	RCA cable (4 heads)	1 piece
6	HDMI cable	1 piece

Pollution control labels and its content descriptions



This symbol indicates the product can be recyclable. The number 10 indicates the period of environmental protection. As long as you follow the safety and precautions related to this product, it will not cause environmental pollution or impact on human property within 10 years from the date of manufacture.

Name and content of toxic or hazardous substances or elements in the product

Part Name	Hazardous substances or elements					
	Lead(Pb)	Mercury(Hg)	Cadmium (Cd)	Hexavalent chromium (Cr ⁶⁺)	Polybrominated (PBB)	Biphenyls polyphenyls (PBDE)
Chassis enclosure	○	○	○	○	○	○
Electrical parts	×	○	○	○	○	○
Plastic structural parts	○	○	○	○	○	○
Metal structural parts	○	○	○	×	○	○
Cables	○	○	○	○	○	○
Transformer	○	○	○	○	○	○
Speaker	×	○	○	×	○	○

Marks:

“○” means the content of the hazardous toxic substance is lower than SJ/T11363-2006 standard required.

“×” means in a homogeneous material of the component, the content of the hazardous toxic substance is higher than SJ/T11363-2006 standard required.

Note: “×” as there are no substitutable substances under the existing technology

Thank you for choosing Tonewinner audio products. We will serve you with "high technology, high quality and high taste" enterprise philosophy, will serve you with exquisite craft, classical circuit, high technologies, first-class quality and first-class services. We will bring all customers with our stable, reliable, durable and pleasant technology achievements!

Catalogue:

- 1. Important protective measures for attention ----- 2
- 2. Features overview ----- 4
- 3. Front panel ----- 5
- 4. Display screen introduction ----- 6
- 5. Rear panel ----- 7
- 6. Remote control ----- 9
- 7. Connecting instruction ----- 11
- 8. Basis setups ----- 15
- 9. Functional introduction and setups ----- 17
- 10. Mobile phone audio wireless transmission ----- 24
- 11. Phone App ----- 24
- 12. Main parameters ----- 26
- 13. Safety protection category: Class II ----- 26
- 14. Problem shooting ----- 27

Important protective measures for attention

	WARNING ELECTRIC DANGER DO NOT OPEN		<ul style="list-style-type: none">■ To reduce risk of electric shock, do not remove the outer cover (or back panel).■ For maintenance, it should be carried out by qualified maintenance people.■ To avoid fire and electric shock hazards, do not get the unit wet or damp.■ Safety protection category: Class II
---	---	---	---

1. Read the protective measures: read all warning messages about protection and operation in the instructions carefully before using the equipment.

2. Follow instructions: please follow the instructions and do not violate the instructions.

3. Place the product on where manufacturer recommends: to protect equipments overturning, do not use force to push or suddenly stop when moving.

4. Keep away from water and moisture: do not place equipment near water such as bathtub, basin, sink, washing machine, etc. Do not use equipment at high temperatures high humidity environment, such as a damp basement.

5. Cleaning: Do not use liquid or mist cleaners, please use dry cloth to clean. Turn off the machine and power off before clean the equipment.

6. Power supply: use the power supply according to indication. Should have reasonable wirings, to avoid damage, do no step. Pay special attention to power plugs, receptacles and connection wirings.

7. Ventilation: the chassis of equipment is designed with venting holes. To ensure reliable performance, please avoid overheating, do not cover the equipment. Do not use the equipment on beds, sofas, carpets etc. Newspapers, tablecloths, curtains, and other objects may block

venting holes. Do not put the equipment close to window curtains. If it is built-in installation, such as bookcase or rack, make sure enough venting. Keep a distance of 10cm (4") on left, right, top and rear sides. Equipment bracket or rear of top cover should have a distance of 10 cm (4 ") to rear panel or the wall, to keep venting space.

8. Heat - to keep products away from heat sources, such as heatsinks, stoves, objects that generate heat (including power amplifiers)

9. Prevent unknown objects or liquids - objects or liquids should be prevented from falling through the holes into the equipment, because it might contact current or live parts that might cause fire or electric shock. Do not place the equipment in rain or water splashing place, do not put into water containers, such as vases.

10. Please connect well all input/output wires before power on.

11. Thunder and lightning: unplug the power cable in thunder and lightning weather, it can effectively prevent lightning impulses to protect the equipment.

12. Protections:①Unplug the power supply when you do not use the manual for long period. Plug. ②Good grounding can prevent the machine from being damaged.

13. Maintenance: do not open the equipment chassis to avoid electric shock.

Please send the machine to our local designated maintenance house if you meet below circumstances and need maintenance.

- a) Unknown parts or liquid enter the machine.
- b) The equipment was soaked.
- c) Abnormal machine operation.
- d) Machine falling or machine damage.

14. Battery: for environmental protection, do not discard the waste electricity optionally.

15. Disconnection device of main power supply: this machine use power plug and coupler as the disconnecting devices. Power plug and coupler should be easily operated.

16. This product is only suitable for safe use in altitude below 2000M.



17. This product is only suitable for use in tropical climates



HD-3100 is a Dolby Atmos DTS:X theater & Karaoke integrated amplifier. It's an all in one machine which combines home theater system, personal music center and professional Karaoke system. HD-3100's professional 5.1.2 channel immersion Karaoke system is pioneering in audio industry. It supports audio return channel (ARC), which can make smart TV turn into song-order machine. It's the high end integrated amplifier which can satisfy all your family entertainment need.

Main features:

1. Dolby Atmos, Dolby True HD and all downward Dolby audio formats.
2. DTS:X, DTS-Master and all downward HD audio formats.
3. HDMI 2.0, HDCP 2.2 and HDMI eARC.
4. 18GHz full bandwidth video signal, supports 4K/60Hz, Dolby Vision and HDR 10 video signal.
5. Stacked OSD menu operation display.
6. Support 7.2.4 in total 13 channels Atmos decoding lineout output.
7. Built-in Karaoke and multi-tap DSP mixing processor.
8. Built-in auto smart room acoustic testing and auto compensation for spectral characteristic, channel loudness and channel distances.
9. Built-in Bluetooth audio receiver function.
10. Built-in audio player function, support files playing from TF card & USB disk, support several lossless & compressed audio format files playing, such as FLAC, APE, WAV, MP3 & etc; support multi-layer folder management.
11. Smart phone App control.
12. Support over 10 kinds of speaker configurations from 2.0 to 7.2.4.
13. HDMI 6 in 2 out, also 2 x COAX, 2x OPT and 3 x ANA inputs.
14. 5.1 channel external mixing inputs, can add external mixer.
15. Built-in 7x150W(8Ω,RMS) Class H high power HiFi amplifier, can drive 5.2 speaker system directly.
16. RS232 integrated controller.
17. HDMI ARC, eARC, and CEC.
18. Max. 1s lipsync adjustment.
19. Each channel has as many as 7 to 11 band parameters EQ.
20. Random combination of video and audio signals from different input sources.
21. Use the latest ADI new due core DSP.
22. Independent settings and parameters storing for input channels.

Dolby, Dolby Atmos, Dolby Audio, Dolby Vision, and the double-D symbol are registered trademarks of Dolby Laboratories Licensing Corporation. Manufactured under license from Dolby Laboratories.

Front panel introduction:

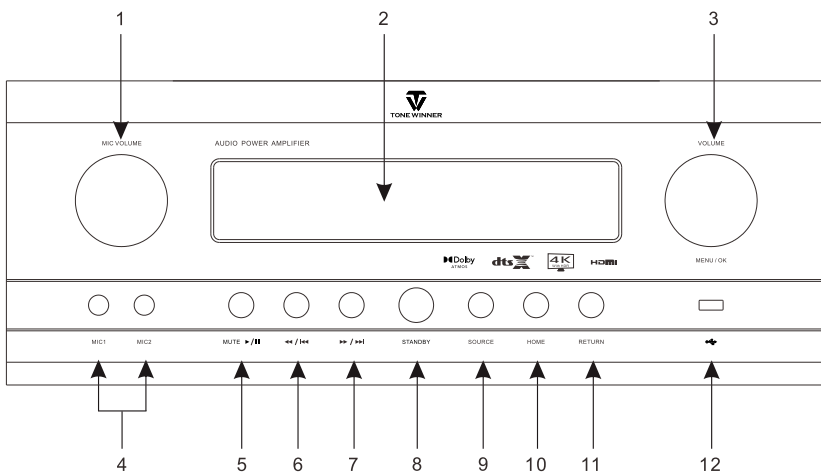

1. MIC VOLUME knob: This knob is for adjusting the volume of microphone. (When playing from TF card and USB disk, you can use this knob for selecting the song you want to play.)

2. Display screen

3. VOLUME/MENU/OK knob:

(1) Rotate the knob under main menu for adjusting volume.

(2) Press the knob for entering the menu.

4. Microphone port (MIC1/MIC2).

5. Mute/Play/Pause button

6. REV/PREV:

Long press for fast reverse, and short press for move previous.

7. FWD/Move next:

Long press for fast forward, and short press for move next.

8. Standby button:

Turn ON/OFF the unit.

9. Source selection:

For selecting different input source.

10. Home button:

Press for switching main interface and menu.

11. Return button

12. USB disk input.

OSD introduction:

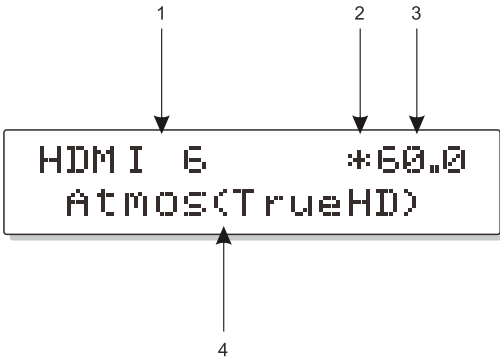

1. Input group info:

Displaying the current selecting input group.

2. * symbol:

When there is audio signal input detected by the unit, it will show up.

3. Volume level info:

Displaying current volume level.

4. Displaying current audio signal information.

Rear panel introduction:

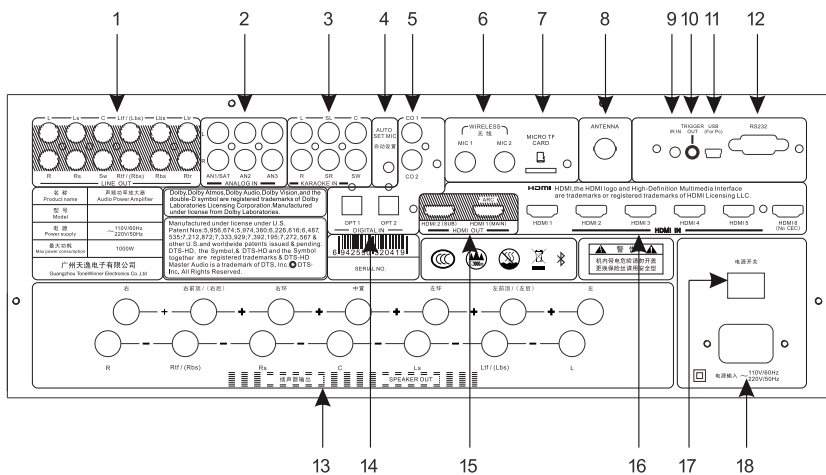

1. 7.1.4 signal output

2. ANALOG IN (L & R): 3 ways analog signals input, AN1, 2,3.

3. 5.1 Karaoke signal input, it also can input 5.1 effector signal.

4. AUTO SET MIC:
Connect the calibrated MIC for collecting information from auto room scanning.

5. Coaxial digital audio input:
2 way Coaxial inputs, CO1 and CO2.

6. Wireless microphone input ports:
MIC1/MIC2.

7. TF card input.

8. ANTENNAS: Bluetooth antennas.

9. IR IN:

For connecting IR receiver, convenient for adding input signals from different devices.

10. TRIG OUT:

5V high level signal output, for triggering out other relative devices.

11. USB(For PC): For playing PC audio.

12. RS232 port:
Remote control port.

13. 7.2 channel power amplify output: For connecting corresponding speakers.

14. Optical digital audio input:
2 way Optical inputs, OPT1 and OPT2.

15. HDMI OUT:

2 ways HDMI output, for connecting the display devices with HDMI port, HDMI1 support ARC.(Remark: when under HDMI standby pass through status, only HDMI1 has output.)

16. HDMI IN:

For connecting to the devices which are with HDMI output ports, such as DVD, network player and etc. (Recommend to use HDMI1,2,3 in priority.)

17. Power on switch

18. Input power(110V/220V) auto switch.

Remote

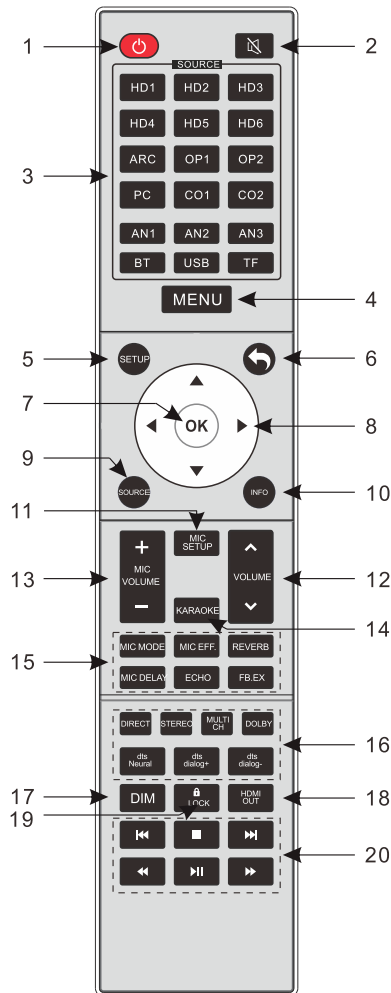

Remote introduction:

1. When installing the battery to the remote, please make sure the batteries are installed correctly.
2. Please don't mix use old & new batteries in the remote.
3. If you didn't need to use the remote for a long time, please take out the batteries.
4. If the receiving distance of the remote is becoming shorter or instable, please replace the batteries.
5. Please use soft cloth to clear the IR diode on the remote and the IR receiving window on the machine regularly.
6. Please don't put the remote in a moist and sultry place & avoid shock and vibration.

1. Switch on button: For turning on the unit into working or standby status.
2. Mute button: Mute or unmute.
3. Input select button: Press this button for selecting the relative input source.
4. Main menu button:
Press this button for entering screen menu.
5. System setting button:
Press this button for entering system setting menu (Hold it for 3 seconds for entering "Load default parameters" menu directly.)
6. Return button: return to previous menu.
7. OK button:
Press for confirming relative function, equals to the Menu/OK knob on the front panel.
8. ▲, ▼, ◀, ▶ direction buttons:
For moving to up, down, left and right direction in the menu.
9. Input selection button:
This button is for co-using with the direction buttons, so you can select different input sources.
10. Info button:
Displaying the information for the current playing track.
11. MIC set button:
Press for entering microphone menu.
12. Music volume button:
For adjusting the output music volume.
13. MIC volume button:
For adjusting the output microphone volume.
14. Cinema/Karaoke switch button(Only works when there is microphone plugged in):
Press this button for loop selections of "Turn off microphone effector", "Built-in effector" and "Pure external vocal".
15. Microphone effect setting button(Need to use with Mic vol+/-).
16. Current cinema/Karaoke audio effect modes for selection zone.
17. Dim: For adjusting the brightness of the OSD.
18. Video output selection:
Select HDMI port which is with input signal.(When you only have one output device, the recommend output port is HDMI2 OUT1).
19. LOCK button:
Press for 3 seconds to lock or unlock the unit.
20. Previous/Next/Forward/Reverse buttons(Only works when reading from USB disk, TF card.)

Connecting Map (speaker and position):

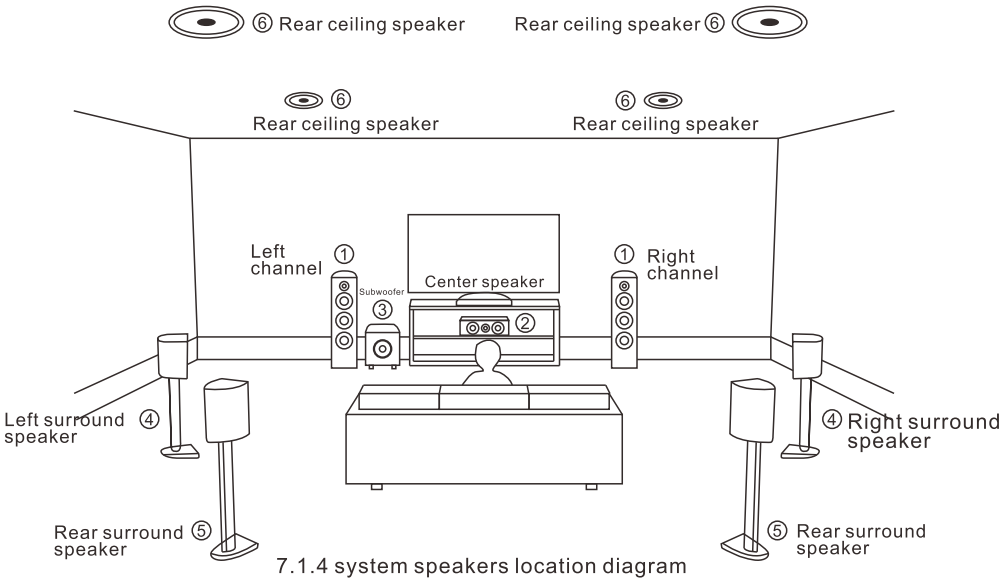

Above diagram is for 7.1.4 system, you can refer to it according to the speakers you have.

1. Front left and right speaker

Front left and right speakers can output the overall sound effects, these speakers play the role of offering a single locating point in sound field of the home theater system. The recommend placing way is facing the listener & in the ear height, the distances between the speakers & listener should be the same as the distance between TV and listener. In order to get a better audition experience, please move the speakers slightly inward, so the listener can be in the vertex of a triangle formed by the speakers and listener.

2. Center speaker

The center speaker reinforced the sound effect of left and right speakers, & it increase the movement of the sound thus make the sound filed completed. The center speaker plays the dialogue in the movie. Please put the center speaker right under or above the display device & make sure it is face to the listener in the ear height or in the same height as the front & left speakers.

3. Subwoofer

Subwoofer handles the bass in the sound field. The sound quality and volume of the subwoofer are closely connected by the shape of your audition room & the position of the listener. The recommend position is a corner of the front part of the room or the one third width of the room.

4. Surround left and right speakers

These speakers are for precise positioning of sounds, & increase the reality of the sound from all directions. Please put these speakers on the sides or slightly backward, the recommend install height is 60cm to 100cm above listener's ears, the ideal position is the distances from the listener to left surround and right surround speakers are the same.

5. Rear surround left and right speakers

When the input signal is Dolby HD or DTS HD, these speakers are needed, they can help to enhance the surround sound effect & create a realistic immersive effect. The recommend install height is 40cm to 100cm above listener's ears.

6. Ceiling speakers

Add sounds in vertical to the system & make a powerfull immersive sound filed for you.

Cinema system connection Diagram

TV, projector, hard disk player,
Blu-ray player, DVD, top box,
game machine

Projector
TV.

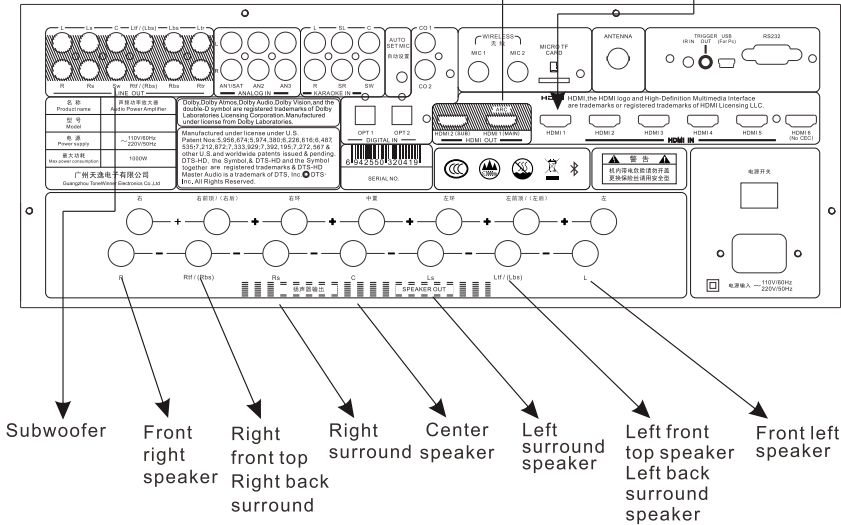

Connection diagram

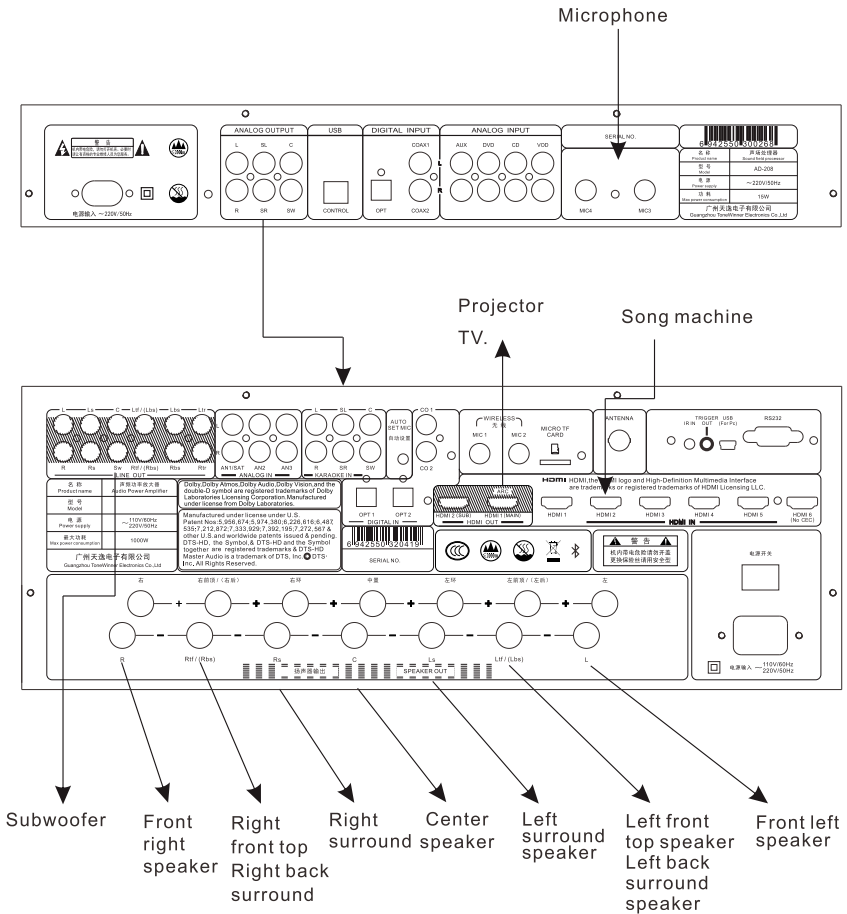

Basic setups (First install and setup instruction)

1. OSD setup menu language select: 中文/English, the default language is English:

Main menu-System setup-Function option-Language/语言

2. Select relative signal source input:

Input selection-Move up and down to select the input or select it on the remote directly.

3. Speaker configuration:

You can set up 7 kinds of speaker configurations based on the speaker quantities you have: 2.0/2.1/5.1/7.1/5.1.2/5.1.4/7.1.2/7.1.4.

Remarks:

- a. When configured as 5.1, there are no outputs from left front top speaker, left rear top speaker, right front top speaker and right rear speaker.
- b. When configured as 7.1, the left front top speaker, left rear top speaker, right front top speaker and right rear speaker are rear left and right channel outputs.
- c. When configured as 5.1.2, the left front top speaker, left rear top speaker, right front top speaker and right rear speaker are top ceiling channel outputs.
- d. When configured as 5.1.4, the left front top speaker, left rear top speaker, right front top speaker and right rear speaker are front top ceiling channel outputs.
- e. When configured as 7.1.2, the left front top speaker, left rear top speaker, right front top speaker and right rear speaker are top ceiling channel outputs.
- f. When configured as 7.1.4, the left front top speaker, left rear top speaker, right front top speaker and right rear speaker are front top ceiling channel outputs.

4. Speaker distance (Latency):

Main menu-System setup-Speaker setup-Speaker distance: You can set the distance from every speaker to you seat.

5. Subwoofer selection:

Main menu-System setup-Speaker setup- Subwoofer selection: You can set here for your system to be with or without subwoofer.

6. Microphone switch:

Remote: Direct KTV/Cinema switch function in circulation;

Turn off effector(Turning off Karaoke & switch to pure cinema mode.);

Built-in effector(Use the built-in Karaoke effector)

Pure external voice(Use the music and video fromHD-3100 & use external effector via analog 5.1 line in as the Karaoke human voice.)

Functional Setups:

1. Input selection (Press NO.9 button on remote):

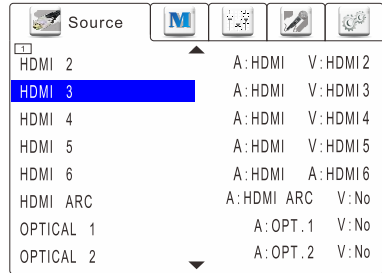
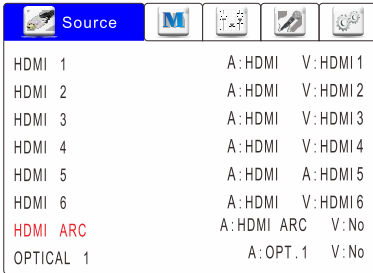

It offers all the signal inputs for selection & displays the input ports for both video and audio.

2. Mode selection (Press NO.16 button on remote):

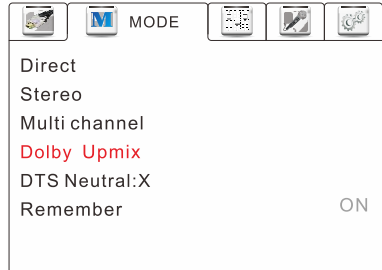
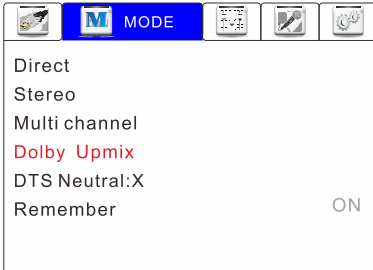

It only applies corresponding DSP processing to the current input source instead of all input sources. It offers 5 modes for option: Direct, two channel, multi-channel, Dolby sound effect and DTS sound effect.

(The mode select only works for the current input source, it will load default settings after reboot.)

3. Parameter adjustment:

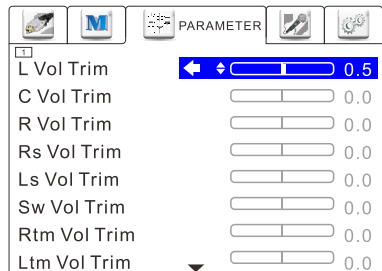
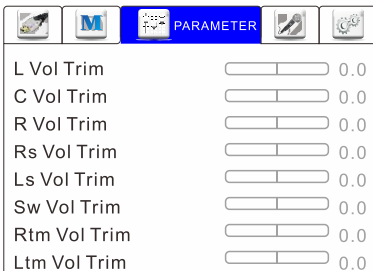

- A. It has the independent output level gain adjustment to each channel & the display will be different based on different speaker configuration. For the channels which are not existing, the display will be in grey color & can't be adjusted.
 - B. Channel volume shutdown memory: ON/OFF
 - C. DTS dialog control: 0-6 (This function is not available if the audio track playing didn't support it.)
 - D. DRC: Auto Dynamic Range Control ON/OFF
- Lipsync time: Auto/0~1000ms.

4. Microphone setting (Press NO.16 button on remote)

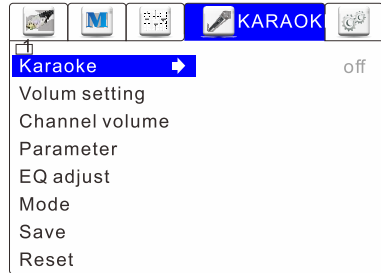
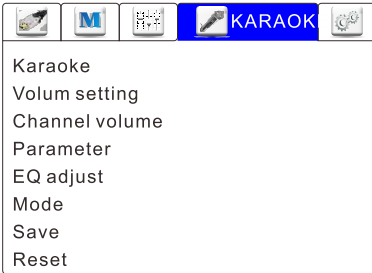

A. Karaoke switch

There are 3 ways to turn ON/OFF the Karaoke function:

- 1) Use the Karaoke button on the remote.
- 2) Set it by MIC setting button.
- 3) Set it under Main menu- Mic setting.

B. Volume set

It offers setting for MIC volume, MIC boot volume, Max MIC volume.

In order to avoid the unnecessary damage to the devices, please set max volume restriction & set the MIC boot volume according to your preference.

C. Channel volume

Set the Karaoke microphone volume for the corresponding channel: There are ± 10 dB adjustable range for Mic center volume, MIC bass volume and MIC surround volume.

D. MIC parameters

It offers 6 kinds of adjustable parameters: Howling suppression, Effector volume, Delay adjustment, Phase, Echo intensity, and Reverberation intensity.

1)Howling suppression: If there is howling when playing Karaoke, please turn on Howling suppression. HD-3100 offers 9 frequency shift points for option, please select the most suitable one based on the actual using operating environment.

2)Effector volume: Effector intensity adjust range is 0 to 30.

3)Delay adjust: Adjust range is 180 to 260ms & adjust step is 25ms.

4)Phase: In-phase/Out-phase.

5)Echo intensity: Adjust the echo intensity from MIC, range: 0 to 10.

6)Reverberation intensity: Adjust reverberation intensity from MIC range: 0 to 10.

E. Timbre adjust:

In order to make it convenient for user to do the timbre adjustment, HD-3100 offers 5 fixing frequencies (Bass, mid-bass, mid, mid- high and treble). User can also adjust MIC sound and effector sound under advance setup. MIC sound has 5 parametric EQ for adjustment & effector has 3 for adjustment.

F. MIC mode:

It offers Factory preset mode & user defined mode for option.

Factory preset mode: It has as many as over 20 kinds of sound effects for option,

User defined mode: User saved the preferred sound effects, in total 3 kinds.

G. Effects saving:

User can save their preferred sound effects.

H. Factory default:

Restore the factory preset data & remove all the information data or setting the user stored.

5. System setting (Press NO.5 button on remote) □

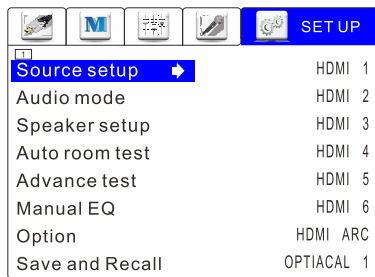
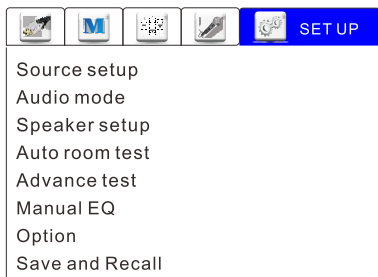

We provide 7 settings as: Input setting □ Audio modes Speaker setting □ EQ setting
Function selections □ Parameter Save and settings Production Information.

A. Input setting: Set ON/OFF, rename, video source, audio source, EQ selection, Karaoke, independent volume, trigger out function of each input channel.

1. ON/OFF: to set ON/OFF status for each audio input port (Off status will not display any signal input port).
2. Input sources: 8 inputs as HDMI1, HDMI2, HDMI3, HDMI4, HDMI5, HDMI6, HDMI ARC, OPTICAL1. (Suggest use the default selection)
3. Video sources: 7 selections of None, HDMI1, HDMI2, HDMI3, HDMI4, HDMI5, HDMI6. (Suggest use the default selection)
4. Audio sources: Synchronize 8 selections of HDMI, OPT1, OPT2, COAX1 COAX2, ANA1, ANA2, ANA3. (Suggest use the default selection)
5. EQ selections: 5 selections of Cinema, Music, Karaoke, Auto EQ and Straight in. (Suggest use the default selection)
6. Karaoke: L/R channel, Center, Surround, High channel, Subwoofer.
7. Independent volume: ON/OFF(Suggest use the default selection)
8. Trigger output: ON/OFF(Suggest use the default selection)

B. Audio formats: set the input signal to expected audio effect.

Input signal: can set into straight in, two channels, multi channels, Dolby Audio Effect , DTS Audio Effect.

C. Speaker settings

1. Speaker layout: choose different speaker layouts bases on your own speakers: 2.0/2.1/5.1/7.1/5.1.2/5.1.4/7.1.2/7.1.4, totally 7 types.
2. High speaker type: choose suitable ceiling speaker and reflective speaker bases on your speaker types.

3. Level test/compensation: test position of each speaker to see if it is correct, and adjust volume gain of different channels to create correct sound field, balance sound effects. System will close the unnecessary channel adjustments base on your speaker layout.
4. Speaker distance (delay): input the distance of each speaker to the listener's position, system will auto adjust speaker delay, to create best sound effects.
5. Subwoofer: if no sub, choose no sub then system will pass the sub signal to relevant channel, so can avoid signal miss to create best sound effects.
6. Frequency response: frequency range of each speaker.
7. Filter slope: set the best filter crossing point slope of high pass and low pass, to create best sound effect.
8. Subwoofer Enhance: if sub is not enough, turn on Subwoofer Enhance to create more impressive sound effects.(note: L and R need to set into full frequency)

D. EQ setting

We provide 5 different modes: Cinema, Music, Karaoke, Auto EQ and Straight in.

For Cinema, Music, Karaoke, Auto EQ these 4 modes, they provide different parameter equalization for different channels under different mode: L/R 11 bands; Center 11 bands; LS/RS 7 bands; LBS/RBS 7 bands; High 7 bands; Sub 5 bands; LFH/RFH 7 bands; LBH/RBH 7 bands.

E. Functions selections

We provide Information of Language, power on setting, volume control, HDMI selection, display information setting, no signal standby, trigger output, unit.

1.Language: Chinese and English

2.Power on setting

Turn on: power up to turn on automatically.

Standby: if unit is on standby when you turn on, then you need to do manual turn on.

Status before turn off: remember the status of last turn off. If unit is turn off when it is standby status, it will be standby when you turn on again. If unit is turn off when it is ON status, it will turn on automatically when you turn on again.

3.Volume control

Turn on volume: to set turn on volume.

Max. volume(IMPORTANT): set max. volume limit, make sure don't make mistake to set the volume into max. to destroy equipment.

Volume step: means how much volume will change when you press remote volume + or -.

Volume display: means how the volume display when you set volume.

4.HDMI selection

HDMI output, Synchronize TV source, Standby straight in, CEC signal sources switch, HDMI signal formats.

a)HDMI output: the amplifier has two HDMI outputs, you can set HDMI 1, HDMI 2, or HDMI 1 & 2 output synchronously (When only HDMI out is connected, suggest to connect HDMI 1)

b)Synchronize TV sources: ON and OFF switch available. ON status, the amplifier will be turn on when TV ON. OFF status, turn off TV, need to turn off amplifier manually.

c)Standby straight in: turn on this function, when unit is Standby, audio and video signal from player equipment will output to display equipment directly (such as TV); turn off this does not activate this function.

d)CEC signal sources switch: turn on this function, when unit is ON, when the connected HMI CEC equipment (such as DVD) turn on or is playing, amplifier will switch to its HDMI channel automatically, customer no need to switch signal source. Make sure it is connected correctly. (this function only support HDMI ARC output port, suggest to turn it off to avoid any mis-operation.

e)HDMI signal formats: 3 options available: Auto, Standard, Enhance. Enhance display high quality HDMI signal.

- Auto: will auto adjust to adapt connected equipment's resolution.
- Standard: support HDMI1.4.
- Enhance: support HDMI2.0(4K/HZ).

f)Display information settings

We provide Dim adjustment, display contents, display location, OSD menu transparency.

- Dim adjustment: unit window dim level, can adjust from 1 to 10.
- Display contents: to display content that are playing, (Off, Only display volume, all display)
- Display location: can be on top or on bottom.
- OSD menu transparency: can adjust from 0 to 7 level.

g)No signal standby: when there is no input signal, or signal was off, to set the time how long it will go into standby.

h)Trigger output: always ON, always OFF, by signal.

i)Unit: Metric system and imperial system (Only for speaker distance)

F. Parameter save and default.

We provide default parameter, load default parameter and factory default settings.

Default parameter: save all the setting parameters.

Load default parameter: default the last save parameters.

Factory default setting: factory default all the settings.

G. Product information:

We provide MCU version, DSP version, Bluetooth name, TV connection1, TV connection2, Firmware updates and More.

Wireless transmission for Mobile phone audio

- (1) Select BT as the audio source on front panel or by remote control.
- (2) Turn on BT on mobile phone, and search HD-3100 equipment, match it till to connect successfully.

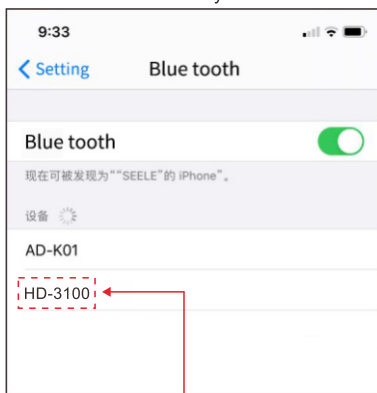

Press to connect

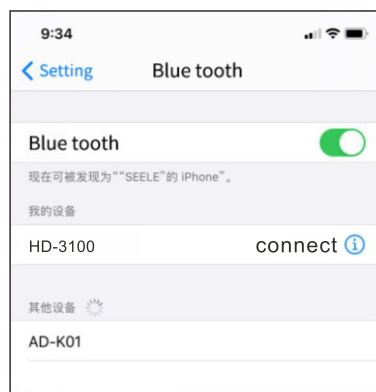

Mobile phone App

For better user experience, Tonewinner develop its own App control to match with its products, user can finish all above operations and switches on phone.

If you are the first time to use Tonewinner App, follow below step1, step2, step3, step4. If you are not the first time use Tonewinner App, follow below step 3.

- (1) Keep your phone on normal working status
- (2) Keep your phone under online status, scan the QR cord on package box, download the HD-3100 App and install it.
- (3) Turn on the Tonewinner App, and search HD-3100 equipment, match it till to connect successfully.

(4) To set the App into English language, follow below 4 pictures.

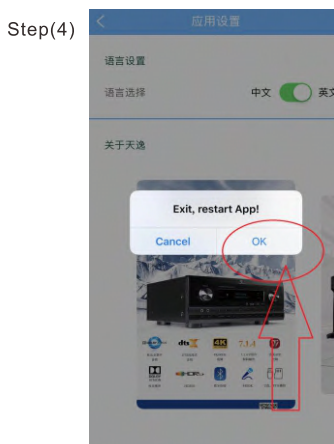
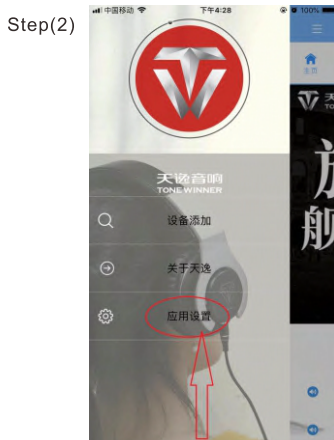

(5) More App control, please check to product details on Tonwinner website
www.tonewinner.com

Please allow no notification when this production has any specification changes.

Product Main Parameters

1. Rated impedance: 8 Ω
2. Rated output power: 230W Rms/4 Ω (THD=1%, one channel, 1KHZ)
150W Rms/8 Ω (THD=1%, one channel, 1KHZ)
3. Distortion: $\leq 0.05\%$, A weight, Analog Bypass, 1KHz normal working status)
4. Frequency response: 20Hz - 20KHz (+1/-3dB, Analog Bypass)
5. Gain: ≥ 40 dB (Analog Bypass)
6. S/N: ≥ 95 dB (A weight, Analog Bypass)
7. N.W: 15.5KGS
8. G.W: 17.6KGS
9. Power supply: $\sim 110/220$ V (50Hz/60Hz)
10. Unit Size: 431x408x179 mm (WxDxH/include binding posts)
11. Standard: GB8898-2011, GB/T13837-2012, GB17625.1.2012)

Safety protection category: Class II equipment.

1. Please read user manual and safety instruction carefully before use the product.
2. The product should put on dry places which have good heat venting condition, far way from water, oil or smoke.
3. The product's safety protection category is class II, its power plug can connect to power grid of ~ 110 V/220V voltage, frequency 50Hz/60Hz.
4. To avoid electric shock, don't open the product by yourself.
5. Don't turn on and off the product too frequently, you need to wait few minutes to return on.
6. When the product fails, please send to professional repair store or send back to Tonewinner factory for repairs. To avoid accident happen, please don't open the unit or fix the unit by yourself.
7. The power socket, power cable, fuses, power switch and power transformer are all safety parts, if user need to replace them, please follow the same specifications on datasheet, and do replace at professional repair store.

Please allow no notification when this production has any specification changes.

Problem Shooting List:

Before contact repair person, please check problem by yourself as below list to find out fail reasons.

Problem	Solution
A.No light up display after connect to power supply.	<ol style="list-style-type: none"> 1.Turn off immediately 2.Check power socket has electronics or not 3.After above steps, turn on again. If still fail, send to repair person.
B.Remote not work or not sensitive enough.	<ol style="list-style-type: none"> 1.Check if IR receive window of this unit is blocked by something. 2.Check remote battery is low power or not.
C.The unit and display work normally, have put signal in but no signal out.	<ol style="list-style-type: none"> 1.Check and make sure all cables are connected well. 2.Check amplifier is normal or not. 3.Check volume is set in Minimum or not. 4.After above steps, if still fail, send to repair person.
D.Microphone no sound or volume too low	<ol style="list-style-type: none"> 1.Check volume of the mic is set in Minimum or not. 2.Check mic is fully plug in or not. 3.Check if mic itself fail. 4.After above steps, if still fail, send to repair person.
E.Microphone squeal or has big noise	<ol style="list-style-type: none"> 1.Mic is too close to speaker 2.Volume of the mic is set too high. 3.Parameter of the mic is not match. 4.Mic is not well plug. 5.Too much high pitch of the mic.
F.OSD display 1080P	<ol style="list-style-type: none"> 1.Select HDMI enchance



Scan QR code

Guangzhou Tonewinner Electronics Co., Ltd

Tel: 86-20-34797660/34796146

Web: <http://www.tonewinner.com>

Add: No.1, Hongsheng 3

Road, Dashi, Panyu, Guangzhou, 511430, China